

VIÐBYGGING

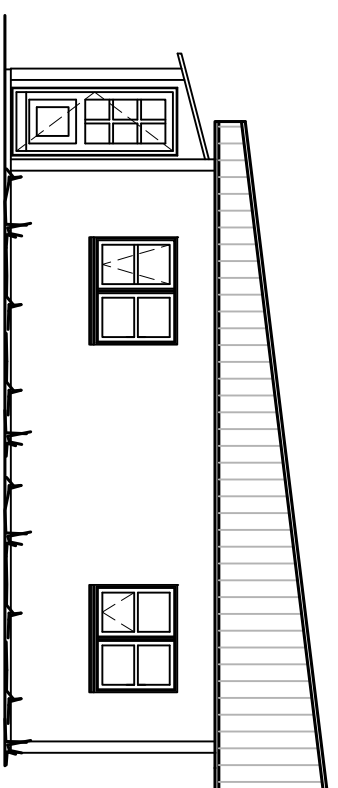

ÚTLIT VESTUR 1:100

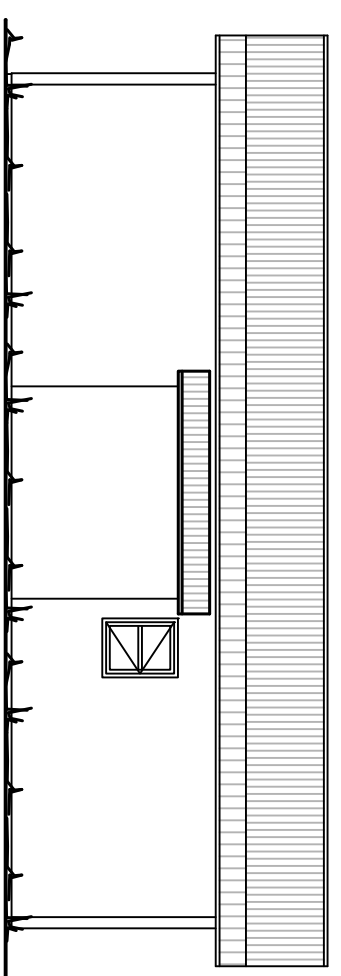

ÚTLIT NORÐUR 1:100

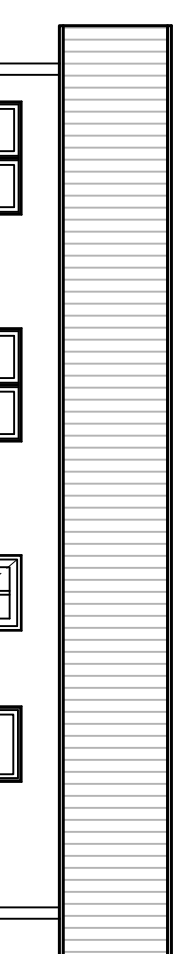

ÚTLIT SUÐUR 1:100

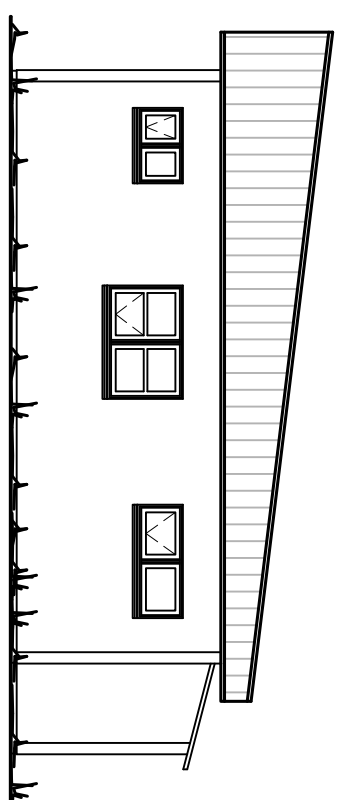

ÚTLIT AUSTUR 1:100

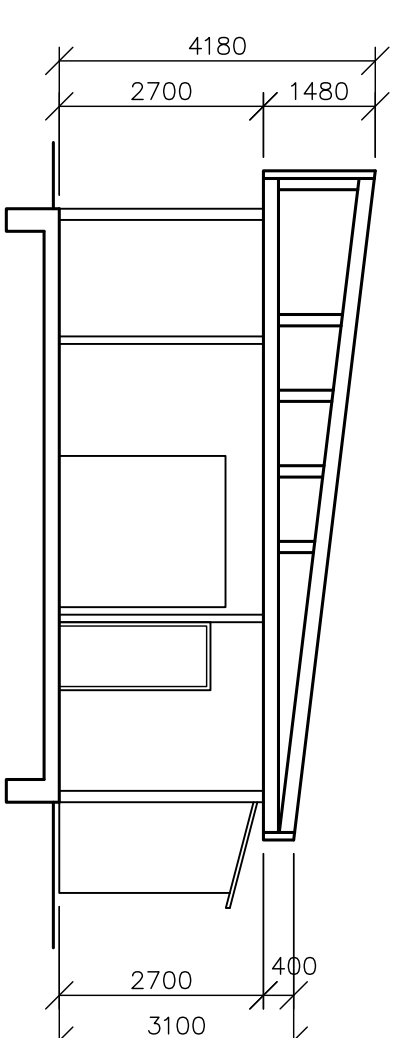

SNID A-A 1:100

BLIGEYMSLA

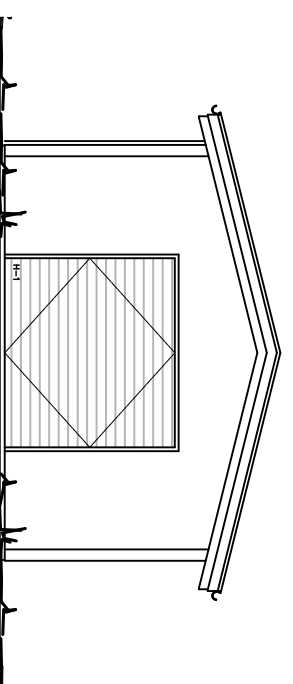

ÚTLIT VESTUR 1:100

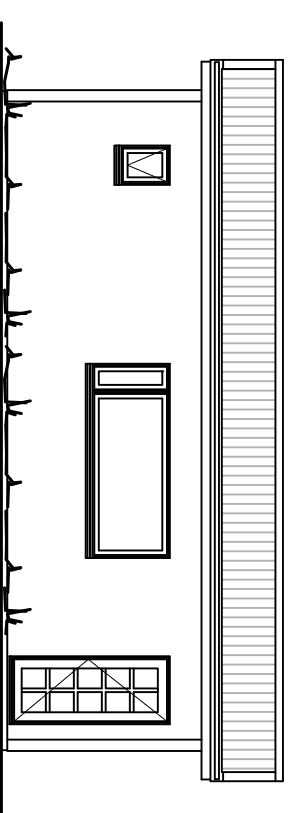

ÚTLIT NORÐUR 1:100

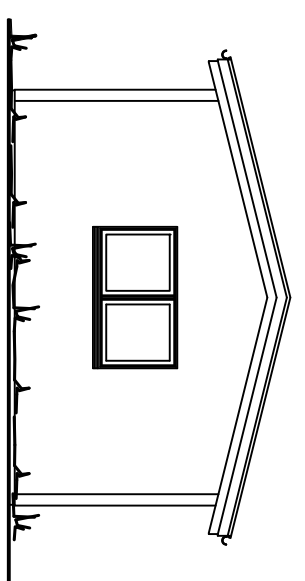

ÚTLIT AUSTUR 1:100

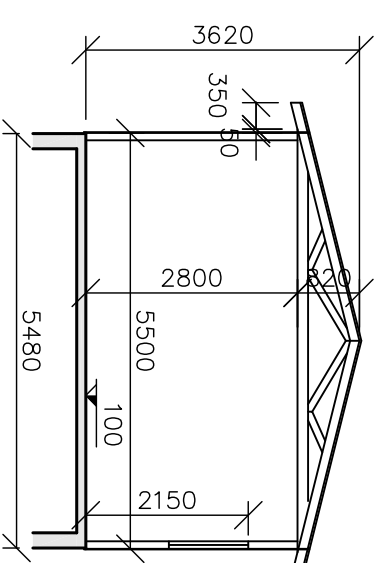

SNID 1:100

Tilvísun:		Heiti teikningar:	
X			
H			
G			
F			
E			
D			
C			
B			
A			
Br. Dags. Af Samþ. Breyting:			

VH Verktæðistofan Hamraborg
 Hamraborg 10 - 200 Kópavogi
 Sími: 554 2200 - Fax: 564 2277

KVENNABREKKA VIÐ ENGUAVEG
 MOSFELLSBÆR VIÐBYGGING MEÐ BLIGEYMSLU

ÚTLIT SNID

VERK NR.	700	KVÆRÐI	BL. NR.
TEKNI. NR.	5287	1:100	02
Höfundur S.G.	Tekni. SG	Yfir. S.G.	Undirtekið
Dagfr. 30.03.2017	Samþykkt SÆVAR GEIRSSON		Breyting
Kl. 150152-4619			